



AMK Commercial Series

## QSA 615-CFM-RVC

Self Amplified 6.5" Coaxial Loudspeaker Assembly



The **AMK QSA615-CFM-RVC** self amplified speakers feature a 30 watt class D digital design amplifier, with > 75% efficiency for the main speaker. This unit is a quatro system of 4 speakers, one powered speaker and three companion speakers. The speaker combines high performance, power handling, and a very smooth response.

The loudspeaker driver, CX602, is one of the few transducers in the commercial sound industry that produces and meets the standards of recording studio. Excellent dispersion, wide bandwidth, and a smooth frequency response make this the top choice for today's overhead commercial applications.

There are wide ranges of the application for this unit, especially in educational markets and corporate boardrooms where direct input of the signal from the processor is desired (i.e., projectors, laptops, or any line level device)

### Features:

- \* All metal construction, including baffle
- \* High performance 6½" coaxial loudspeaker with wide dispersion
- \* Self powered with 30 watt Class D amplifier
- \* **UL Listed Speaker Enclosure (UL 1480, UL 2043)**

## Innovative Features

Each system includes a renowned AMK Coaxial loudspeaker like those already installed in hundreds of locations

### Easy to install

- All-metal swivel mounting system allows standard installation of speakers without having to align the enclosure to the tile bridge
- This installation procedure is quick and unique to the industry
- Architecturally pleasing white perforated metal grille that uses a unique metal spring system for a "no visible hardware finished look and the ease of a "snap on" installation

### Safety

- The use of all-metal attachment parts makes for an overall safer installation
- All-metal swivel prevents breakage of swivel during installation
- All-metal swivel mounting system is not easily compromised by fire

### Sound

- The plenum compatible back enclosure is designed to maximize the performance of this studio quality speaker

## Specifications

Frequency Response	65 Hz - 20 kHz
Voice-coil diameter	1"
Average Beamwidth @ 2 kHz	144 deg.
Magnet Weight	13 oz
Magnet Material	Barium Ferrite
Tweeter	13mm Polyamide Soft Dome
Woofer Cone	Polypropylene
Crossover Frequency	5.0 kHz
Depth of the Enclosure	10 in.
Diameter of the Grille	12.75 in.
Enclosure Mounting	Metal Swivel Clamp
Certifications and Listing	UL 1480 / 2043, CE, RoHS

## Amplifier Specifications

Amplification	30 watt Class D digital amplifier
Amplifier Efficiency	> 75%
Total Harmonic Distortion	< 0.2%
Signal to Noise Ratio	>95dB
Protection	Protected as to short circuit to supply and ground, as well as minimum current
Controls	Input potentiometer level adjustment

## FREQUENCY RESPONSE



## IMPEDANCE CURVE

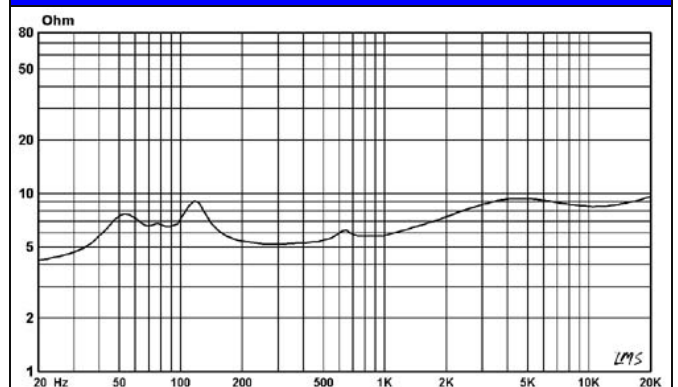

# MODEL CONFIGURATION

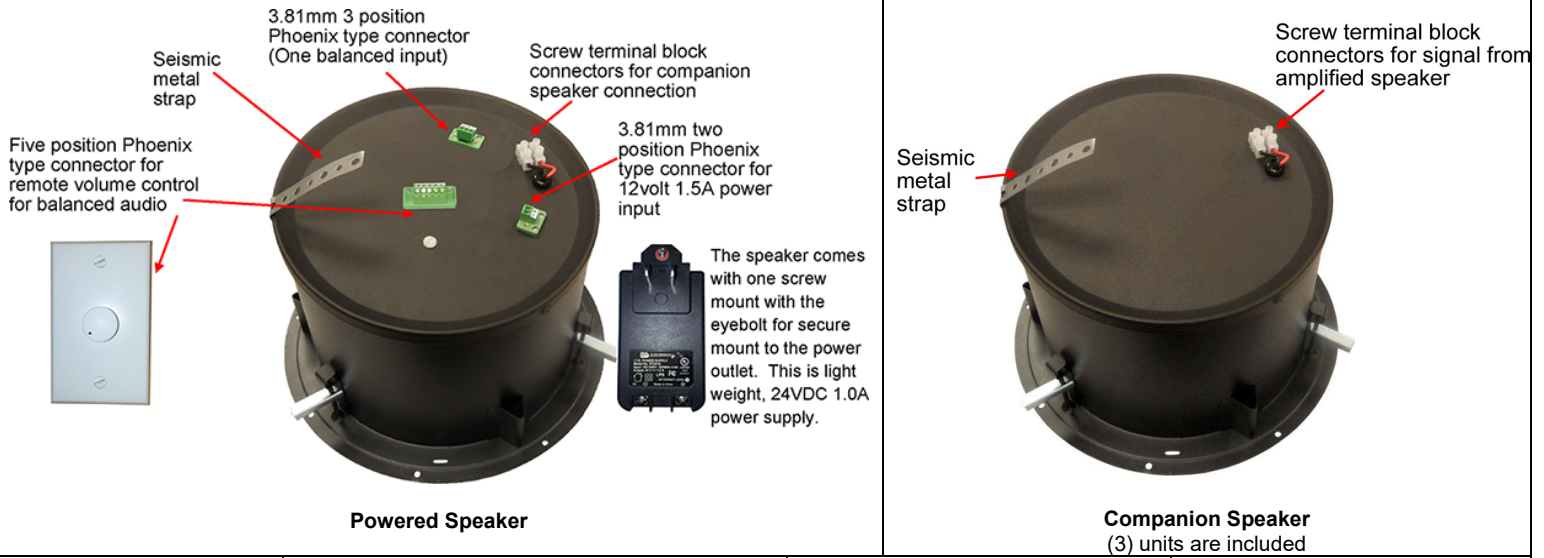

<b>Power Supply</b>	External 12Volt w/ Screw Terminal	<b>Signal Input</b>	One balanced input
<b>Power Connection</b>	3.81mm two position Phoenix type connector	<b>Companion speaker input/output connections</b>	Screw terminal block connectors
<b>Input Connection</b>	3.81mm three position Phoenix type connector	<b>Input Level Adjustment</b>	External with five position inputs
<b>Additional Suffixes</b>	The part numbers listed include the <b>TB8R</b> for use with suspended ceilings and speaker Grills For hard lid applications please add either of the following at no additional charge:- <b>SACSD</b> for the metal C ring for retro fit applications. <b>-MD8</b> For the pre-construction mud ring.		

## Wiring Diagram

All the speakers are connected in parallel

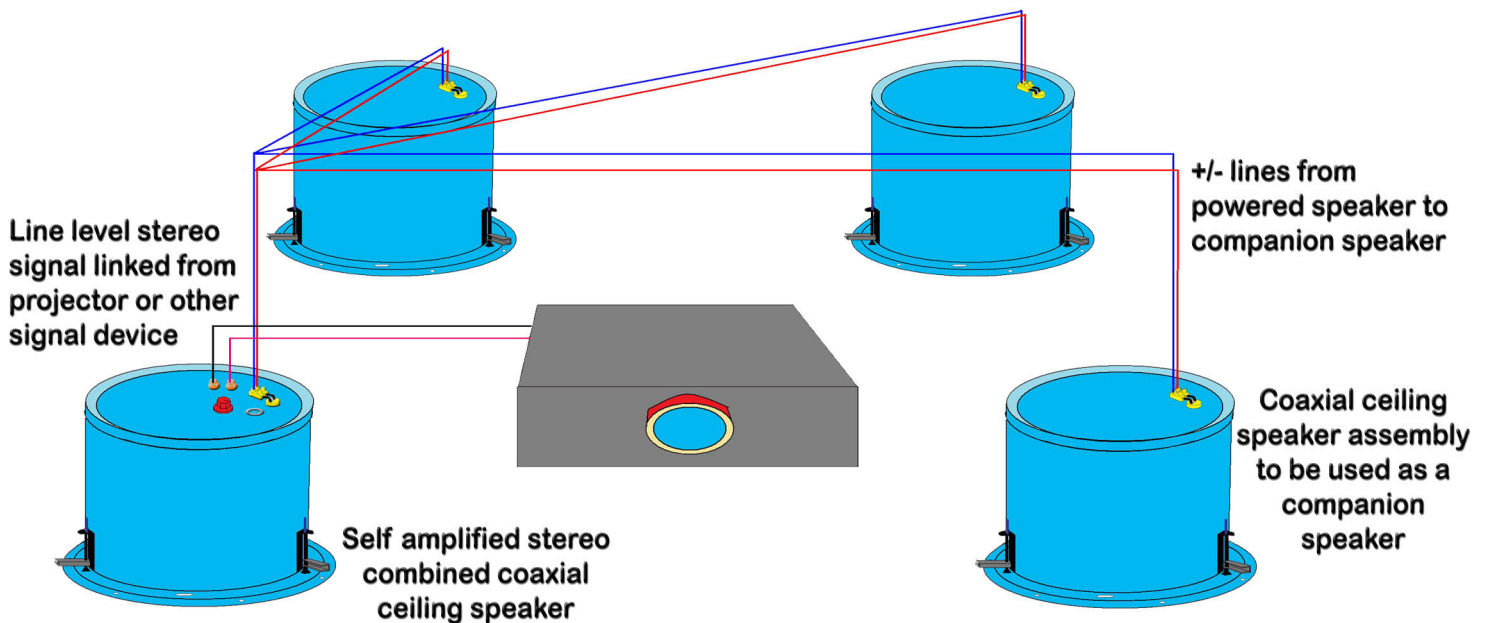

# QSA 615-CFM-RVC ILLUSTRATION

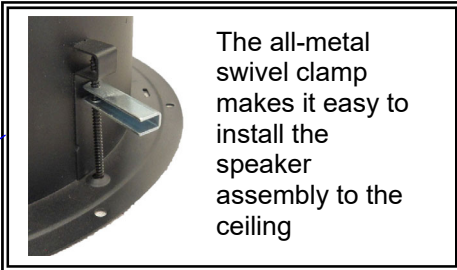
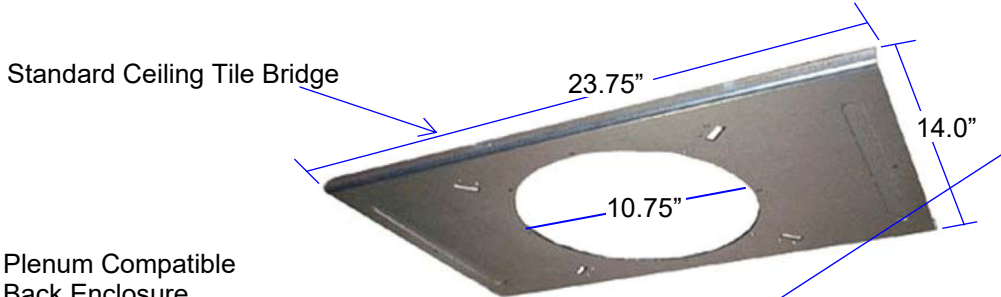

Plenum Compatible Back Enclosure  
**NFPA-70** National  
 Electric Code, **UL 1480**  
 and **UL 2043**, Speakers  
 for Fire Protective  
 Signaling Systems

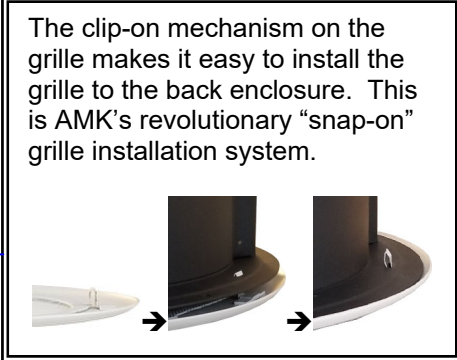
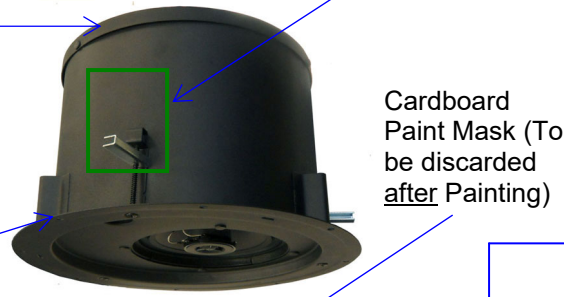

Guide for alignment of enclosure to tile bridge for grille installation

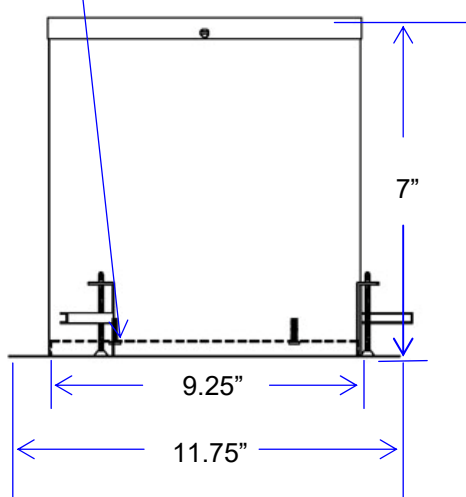
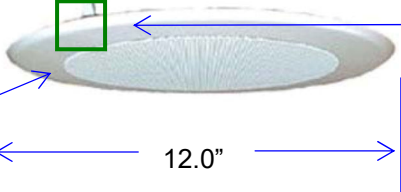

## Architect's & Engineer's Specifications

The powered loudspeaker system shall be **AMK QSA 615-CFM-RVC** . The speaker shall feature a 30watt Class D digital amplifier, with >75% efficiency for the speaker. The powered speaker systems shall be one amplified speaker with three companion speakers.

The loudspeaker system shall have a white metal round grille with a mounting spring tab snaps into the rim of the enclosure.

The powered unit of the system shall have one 3.81mm three position phoenix type connector for balanced audio input. The input level shall be control by the external potentiometer provided with mounting plate. The power connection shall be a 3.81mm two position phoenix type connector. The system shall have 12 volt 1.5 Amps screw mount power supply.

The loudspeaker unit in the system shall be of the coaxial type with an 6.5" woofer of polypropylene, an inverted rubber surround, and a 1" polyamide soft dome tweeter mounted on a post. The transducer in the loudspeaker system shall be AMK CX 602 coaxial loudspeaker. The woofer shall have a 13 oz. (369g) Barium Ferrite magnet. The two reproducer sections shall be coupled through a built-in capacitor bypass crossover.

The crossover frequency shall be at 5.0 kHz. The low frequency reproducer shall have 1" (25.4mm) voice coil and the high frequency reproducer shall have 0.51" (13mm) voice coil. The system shall have a frequency response of 65 Hz- 20 kHz (+/- 5dB). The sensitivity shall be 91dB at 1watt / 1meter.

The depth of the each enclosures shall be 7 inches. The rim diameter shall be 11.75". The enclosure diameter shall be 9.25". The depth of the each enclosures shall not exceed 11.75". The system shall include a tile bridges. The system shall have a metal strap for attachment to the structure for seismic protection.

The total weight of the each unit system shall not exceed 10.0 lbs.

The loudspeaker system shall be AMK Innovations model **QSA 615-CFM-RVC**.

**Conforms to EIA Standards: RS-276-A, RS-278-B, RS-426-A**

## Polar Responses

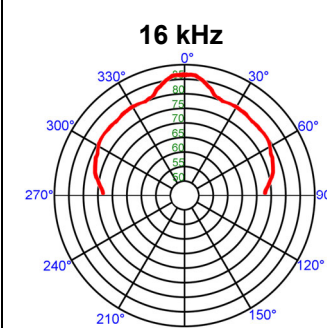
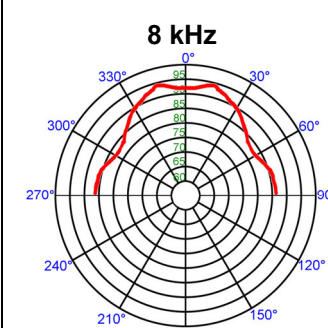
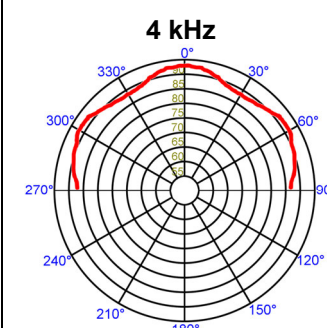
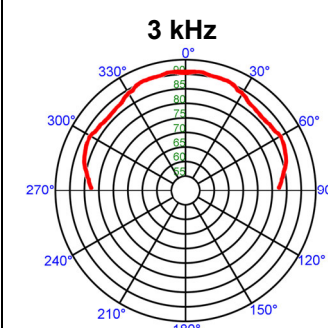
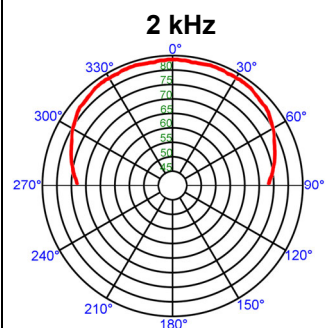
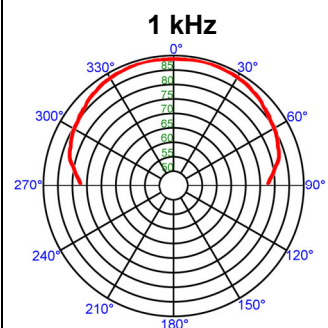
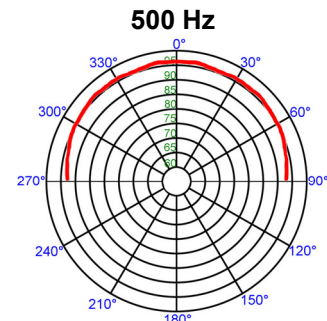
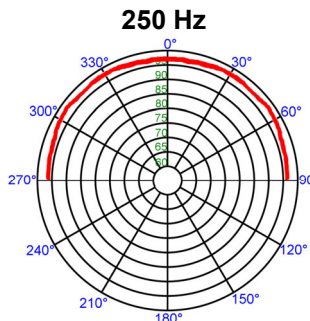

Freq	Deg	Q	DidB
250 Hz	100°	3.8	5.8
500 Hz	96°	4.8	6.8
1 kHz	79°	6.8	8.3
2 kHz	72°	6.7	8.2
3 kHz	66°	9.2	9.6
4 kHz	86°	8.4	9.2
8 kHz	40°	7.1	8.5
16 kHz	16°	15.3	11.8